

# greenworks

2402207AU

EN

BLOWER

OPERATOR MANUAL

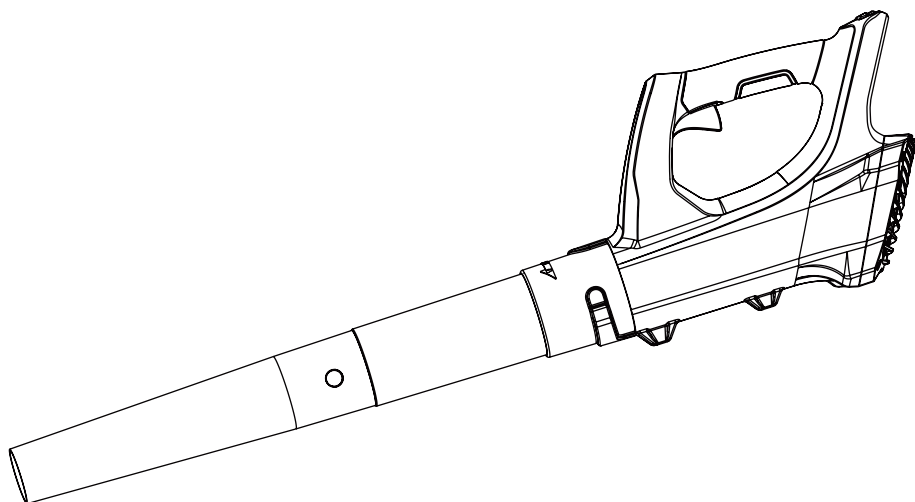

**E8038**

**BLG302**

Greenworks Australia  
A Division Jak Max P/L  
380 Foley's Road Derrimut  
Victoria, Australia 3026

[www.greenworksaustralia.com](http://www.greenworksaustralia.com)

<b>1</b>	<b>Description.....</b>	<b>2</b>	8.1	Unpack the machine.....	5
1.1	Purpose.....	2	8.2	Install the blower tube.....	5
1.2	Overview.....	2	8.3	Install the battery pack.....	5
<b>2</b>	<b>Introduction.....</b>	<b>2</b>	8.4	Remove the battery pack.....	5
2.1	Residual risks.....	2	<b>9</b>	<b>Operation.....</b>	<b>5</b>
<b>3</b>	<b>General power tool safety</b>		9.1	Start the machine.....	5
	<b>warnings.....</b>	<b>2</b>	9.2	Stop the machine.....	5
3.1	Training.....	2	9.3	Operation tips.....	5
3.2	Preparation.....	2	<b>10</b>	<b>Maintenance.....</b>	<b>6</b>
3.3	Maintenance.....	3	10.1	Clean the machine.....	6
<b>4</b>	<b>Blower safety warnings.....</b>	<b>3</b>	<b>11</b>	<b>Transportation and storage.....</b>	<b>6</b>
<b>5</b>	<b>Symbols on the product.....</b>	<b>4</b>	11.1	Move the machine.....	6
<b>6</b>	<b>Risk levels.....</b>	<b>4</b>	11.2	Store the machine.....	6
<b>7</b>	<b>Recycle.....</b>	<b>5</b>	<b>12</b>	<b>Troubleshooting.....</b>	<b>6</b>
<b>8</b>	<b>Installation.....</b>	<b>5</b>	<b>13</b>	<b>Technical data.....</b>	<b>6</b>
			<b>14</b>	<b>Warranty.....</b>	<b>6</b>

# 1 DESCRIPTION

## 1.1 PURPOSE

The machine is used to propel air out of a tube to move unwanted materials such as leaves in the yard. Some machines also suck in leaves and small twigs through a vacuum, and shred them into a bag.

## 1.2 OVERVIEW

Figure 1 - 4

1	Trigger	5	Tab
2	Rear tube	6	Hole
3	Front tube	7	Tab
4	Groove		

# 2 INTRODUCTION

Your product has been engineered and manufactured to high standards for dependability, ease of operation, and operator safety. When properly cared for, it will give you years of rugged, trouble-free performance.

## 2.1 RESIDUAL RISKS

Even when using the power tool properly, remaining risks may exist. The following hazards may occur based on the construction of the equipment:

- Lung damage when not wearing a suitable protective mask.
- Hearing damage when not wearing suitable ear protection.
- Hand/arm damage due to vibration when you use the equipment for extended periods, or the machine is not properly operated and maintained.

# 3 GENERAL POWER TOOL SAFETY WARNINGS

**▲ WARNING**

**Read all safety warnings and all instructions. Failure to follow the warnings and instructions may result in electric shock, fire and/or serious injury.**

Save all warnings and instructions for future reference.

The term "power tool" in the warnings refers to your battery-operated (cordless) power tool.

## 3.1 TRAINING

- Read the instructions carefully. Be familiar with the controls

and the correct use of the machine.

- Never allow children, persons with reduced physical, sensory or mental capabilities or lack of experience and knowledge or people unfamiliar with these instructions to use the machine. Local regulations can restrict the age of the operator.
- Keep in mind that the operator or user is responsible for accidents or hazards occurring to other people or their property.

## 3.2 PREPARATION

- While operating the power tool always wear substantial footwear and long trousers. Do not operate the power tool when barefoot or wearing open sandals. Avoid wearing clothing that is loose fitting or that has hanging cords or ties.
- Thoroughly inspect the area where the power tool is to be used and remove all objects which can be thrown by the power tool.
- Before using, always visually inspect to see, that fasteners

are secure, the housing is undamaged and that guards are in place.

- Never operate the machine while people, especially children, or pets are nearby.
- Obtain ear protection and safety glasses. Wear them at all times while operating the machine.

### 3.3 MAINTENANCE

- Keep all nuts, bolts and screws tight to be sure the power tool is in safe working condition.
- Always allow the power tool to cool down before storing.
- Maintain the machine with care and keep it clean. Do not touch moving hazardous parts until the battery is removed and the moving hazardous parts have come to a complete stop.
- Allow the machine to cool before making any inspections, adjustments, storing etc.
- Replace worn or damaged parts for safety. Use only genuine replacement parts and accessories.



## 4 BLOWER SAFETY WARNINGS







- Operate the appliance only in daylight or in good artificial light.
- Keep all cooling air inlets clear of debris.
- Never blow debris in the direction of bystanders.
- Before starting the machine, make certain that the tube inlet is empty.
- Keep your face and body away from the air intake opening.
- Do not allow hands or any other part of the body or clothing inside the tube inlet, discharge chute, or near any moving part.
- Inspect unit to ensure no foreign material/ debris is in the machine prior to operation.
- Never operate the machine with defective guards or shields, or without safety devices or if the cord is damaged or worn.
- Do not overreach. Keep balance at all times, and always be sure of the footing on slopes. Walk, never run.

- Stop the machine and remove the battery pack. Make sure that all moving parts have come to a complete stop,
  - whenever the machine is left by the user
  - before clearing a blockage
  - before checking, cleaning or working on the machine
  - after striking a foreign object to inspect the machine for damage
- If the machine starts to vibrate abnormally,
  - inspect for damage
  - replace or repair any damaged parts
  - check for and tighten any loose parts

## 5 SYMBOLS ON THE PRODUCT



Some of the following symbols may be used on this tool. Please study them and learn their meaning. Proper interpretation of these symbols will allow you to operate the tool better and safer.

Symbol	Explanation
	Read operator's manual.
	Keep bystanders away.



Symbol	Explanation
	Wear eye and ear protection.
	Do not expose the product to rain or moist conditions.
	Keep all bystanders at least 15m away.
	Do not touch the fan when you operate this machine.
	Failure to keep loose clothing from being drawn into air intake could result in personal injury.
	Failure to keep long hair away from the air inlet could result in personal injury.
	Rotating impeller blades can cause severe injury.

## 6 RISK LEVELS

The following signal words and meanings are intended to explain the levels of risk associated with this product.

SYMBOL	SIGNAL	MEANING
	DANGER	Indicates an imminently hazardous situation, which, if not avoided, will result in death or serious injury.
	WARNING	Indicates a potentially hazardous situation, which, if not avoided, could result in death or serious injury.
	CAUTION	Indicates a potentially hazardous situation, which, if not avoided, may result in minor or moderate injury.
	CAUTION	(Without Safety Alert Symbol) Indicates a situation that may result in property damage.

## 7 RECYCLE

	<p>Separate collection. You must not discard with usual household waste. If it is necessary to replace the machine, or if it is no more use to you, do not discard it with household waste. Make this machine available for separate collection.</p>
	<p>Separate collection of used machine and packaging let you recycle materials and use them again. Use of the recycled materials helps prevent environmental pollution and decreases the requirements for raw materials.</p>
	<p>At the end of their useful life, discard batteries with a precaution for our environment. The battery contains material that is dangerous to you and the environment. You must remove and discard these materials separately at a equipment that accepts lithium-ion batteries.</p>

## 8 INSTALLATION

### 8.1 UNPACK THE MACHINE

#### ▲ WARNING

Make sure that you correctly assemble the machine before use.

#### ▲ WARNING

- If the parts have damage, do not use the machine.
- If you do not have all the parts, do not operate the machine.
- If the parts are damaged or missing, speak to the service center.

1. Open the package.
2. Read the documentation in the box.
3. Remove all the unassembled parts from the box.
4. Remove the machine from the box.
5. Discard the box and package in compliance with local regulations.

### 8.2 INSTALL THE BLOWER TUBE

Figure 2 - 3.

1. Align the grooves on the rear tube with tabs on the blower housing.
2. Install the rear tube onto the blower housing until the tabs engage the grooves.
3. Turn the rear tube in the direction of the arrow until the two tabs lock into the positions.

4. Align the hole on the front tube with the tab on the rear tube.
5. Install the front tube onto the rear tube until the tab lock into the position.

### 8.3 INSTALL THE BATTERY PACK

Figure 4.

#### ▲ WARNING

- If the battery pack or charger is damaged, replace the battery pack or the charger.
- Stop the machine and wait until the motor stops before you install or remove the battery pack.
- Read, know, and do the instructions in the battery and charger manual.

1. Align the lift ribs on the battery pack with the grooves in the battery compartment.
2. Push the battery pack into the battery compartment until the battery pack locks into place.
3. When you hear a click, the battery pack is installed.

### 8.4 REMOVE THE BATTERY PACK

Figure 4.

1. Push and hold the battery release button.
2. Remove the battery pack from the machine.

## 9 OPERATION

#### ▲ WARNING

Make sure the blower tube is in position before operation.

### 9.1 START THE MACHINE

Figure 1.

1. Pull the trigger to start the machine.
2. Pull the trigger fully to increase the speed.
3. Release the trigger to decrease the speed.

### 9.2 STOP THE MACHINE

Figure 1

1. Release the trigger to stop the machine.

#### i NOTE

Wait until the engine stops after you stop the machine.

### 9.3 OPERATION TIPS

- Blow around the outer edge of the unwanted materials to prevent the unwanted materials from scattering.
- Use rakes and brooms to clear the unwanted material before you blow.

- Make the surfaces wet before you clear the unwanted material in dusty conditions.
- Look out for children, pets, open windows, and cleaned cars during operation.
- Clean the machine.
- Discard the unwanted material when you complete work.

## 10 MAINTENANCE

### ▲ CAUTION

Do not let brake fluids, gasoline, petroleum-based materials touch the plastic parts. Chemicals can cause damage to the plastic, and make the plastic unserviceable.

### ▲ CAUTION

Do not use strong solvents or detergents on the plastic housing or components.

### ▲ WARNING

Remove the battery pack from the machine before maintenance.

### 10.1 CLEAN THE MACHINE

### ▲ CAUTION

The machine must be dry. Humidity can cause risks of electrical shocks.

- Clear the unwanted material out of the air vent with a vacuum cleaner.
- Do not spray the air vent or put the air vent in solvents.
- Clean the housing and the plastic components with a moist and soft cloth.

## 11 TRANSPORTATION AND STORAGE

### ▲ WARNING

Remove the battery pack from the machine before transportation and storage.

### 11.1 MOVE THE MACHINE

- Only hold the machine with the handgrip.

### 11.2 STORE THE MACHINE

- Clean the machine before storage.
- Make sure that the motor is not hot when you store the machine.
- Make sure that the machine does not have loose or damaged parts. If it is necessary, do these steps/ instructions:
  - Replace the damaged parts.

- Tighten the bolts.
- Speak to a person of an approved service center.
- Store the machine in a dry area.
- Make sure that children cannot come near the machine.

## 12 TROUBLESHOOTING

PROBLEM	POSSIBLE CAUSE	SOLUTION
The motor does not start when you pull the trigger.	The battery pack is not installed tightly.	Make sure that you tightly install the battery pack in the machine.
	The battery pack is out of power.	Charge the battery pack.
The machine does not start.	The power switch is defective.	Replace the defective parts by an approved service center.
	The motor is defective.	
	The PCB board is defective.	
The air does not flow through the tube when you start the machine.	The air inlet or tube outlet has a blockage.	Remove the blockage.

## 13 TECHNICAL DATA

Voltage	24 V DC
Air volume	9.4 m <sup>3</sup> /min
Air speed	161 km/h
Weight (without battery pack)	1.5 kg
Measured sound pressure level	L <sub>PA</sub> = 86.8 dB(A), K <sub>PA</sub> = 3 dB(A)
Guaranteed sound power level	L <sub>WA,d</sub> = 106 dB(A)
Vibration	< 2.5 m/s <sup>2</sup> , K = 1.5 m/s <sup>2</sup>

## 14 WARRANTY

(The full warranty terms and conditions can be found on Greenworks webpage)

The Greenworks warranty is 4 years on the product, and 2 years on batteries (consumer/private usage) from the date of purchase. This warranty covers manufacturing faults. A faulty product under warranty might be either repaired or replaced. A unit that has been misused or used in other ways than described in the owner's manual might be rejected for warranty. Normal wear, and wear parts are not considered as warranty. The original manufacturer warranty is not affected by any additional warranty offered by a dealer or retailer.



A faulty product must be returned to the point of purchase in order to claim for warranty, together with the proof of purchase (receipt).